

Innovative sign solutions for the rail industry



We do it your **Wayfinding**



VistaRailways
Innovative sign solutions for the rail industry  Line



With Vista Railway Line you get what can be expected from a leading international sign manufacturer:

Availability of service through thousands of sign professionals worldwide

MCFT technology - Modular Curved Frame Technology: A modular system with the ability to provide highly customisable solutions that meet the unique requirements of each sign project. Modern, contemporary, and a clean look. Simple to use and easy to update by yourself. Maximum modularity with wide range of sizes. Comprehensive solution with an unrivaled range of applications that cover the entire project for a competitive price.

High quality, 100% guaranteed product.

Table of Contents:

Exterior Signs	1-6
Lobby	7 - 42
Platforms	43-58
Parking	59-82
Interior Signs	83-93
Tough signs for busy environments	94



MCFT Modular Curved Frame Technology

Exterior Signs

Vista System signs are the result of innovative design combined with unsurpassed technology. Each sign is designed to deliver peace of mind. Vista's Modular Curved Frame Technology (MCFT) is the answer for projects that require the look and feel of custom made contemporarily designed signs without the high cost and hassle. coupled with the high availability of service through thousands of sign professionals worldwide make Vista a natural choice for public projects.





DSV600/2300

Exterior Signs



■ A wide range of sizes can be fabricated by expanding the extrusions to fit the standard bases and end caps.

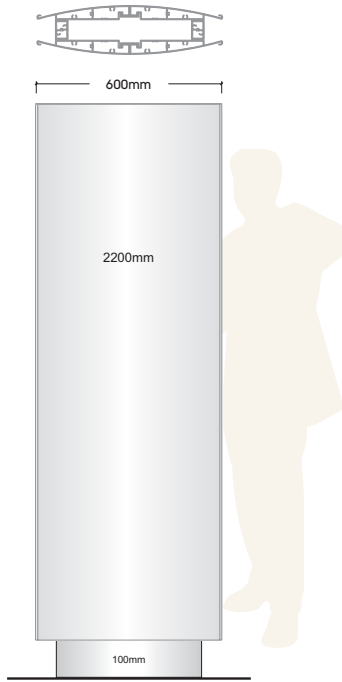

Double Sided Pylons

DSV600/2300

Frame size: V600/2300mm

Insert size: 597.5/2300mm





A critic is a gong at a railroad crossing clanging loudly and vainly as the train goes by Christopher Morley (1890 - 1957)

DSV300/2200

Exterior Signs



■ Vista system offers a range of bases and end caps that utilise the built in screw bosses allowing all sign holders to be assembled, simply using only a screwdriver.

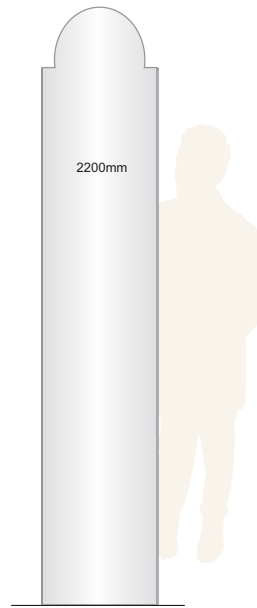
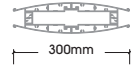

Double Sided Pylons

DSV300/2200

Frame size: 300/2200mm

Insert size: 297/2200mm



V

ista System sign offers a modular design, clear, precise and innovative, simple and functional.

Lobby

What do you expect from your sign supplier?
Choosing a sign system for your project is a vital decision.

Flexibility and choice is highly important.

A good sign system is one that is well accepted by leading sign professionals anywhere near you, that can be easily installed, updated, upgraded and maintained quickly even by in-house staff. Vista Railway Line offers you that and much more.





If you board the wrong train, it's no use running along the corridor in the other direction. - Dietrich Bonhoeffer

DSV600/2300



■ This feature of the system is used to create freestanding convex, double-sided signs to be used with standard sign substrates, without interior illumination.

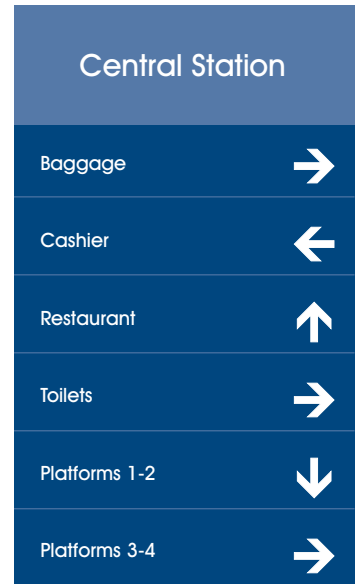
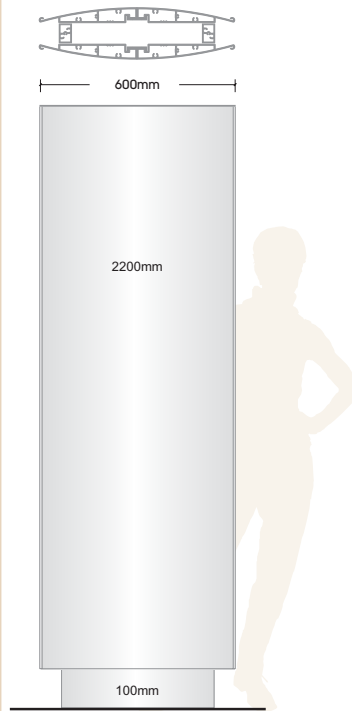

Double Sided Pylons

DSV600/2300

Frame size: 600/2300mm

Insert size: 597.5/2300mm

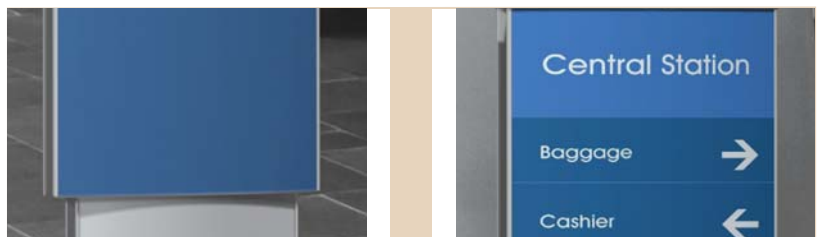



V150/170



■ Create wall-mounted signs with the Vista frame extrusions using any flat, flexible substrate to create a curved-face sign.

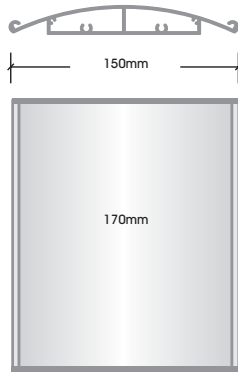

Wall Frames - Portrait

V150/170
 Frame size: 150/170mm
 Insert size: 147/170mm



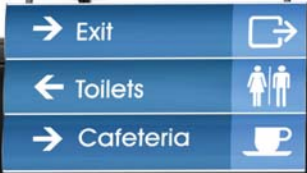

*Most people have that fantasy of catching the train
that whistles in the night. - Willie Nelson*

V200/1000



■ Vista system standard profiles and end caps are used with specially designed connectors that are also cable clamps, to create unending combinations of vertically curved double-sided suspended signs.

↑ Exit		Platform 1 + 2	↑
← Toilets		Platform 1 + 2	←
→ Cafeteria		Platform 1 + 2	→

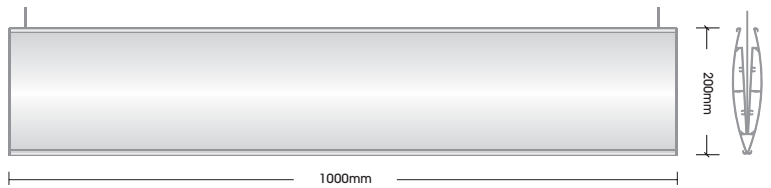

Suspended

V200/1000

Frame size: 200/1000mm

Insert size: 196/1000mm





SUS2V200/1000

Lobby



■ Vista System standard profiles are used with specially designed end caps to create a large variety of vertically curved double-sided suspended signs. Any flat flexible substrate can be used as a sign insert.

Entrance	↑	Buses and Taxi	
Exit	→	Car Parking	
Left Luggage		Cafeteria	
No Entrance		Trolley Point	

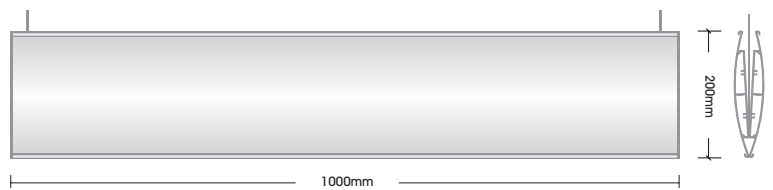

Suspended

SUS 2V200/1000mm
 Frame size: 200/1000mm
 Insert size: 196/1000mm

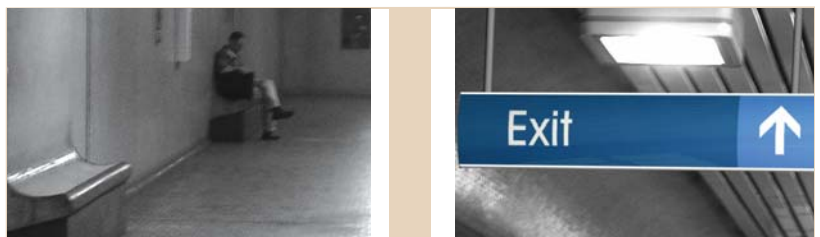



V200/350

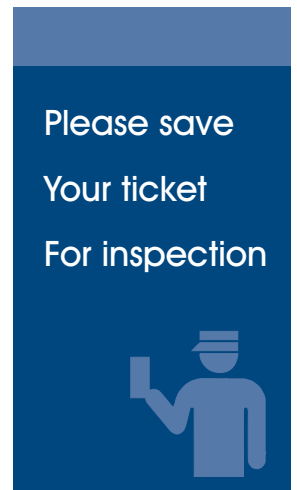

Wall Frames

V200/350
Frame size: 200/350mm
Insert size: 196/350mm

■ Components: Vista extrusions are available from 30mm/1.18" to 1200mm/48" wide.

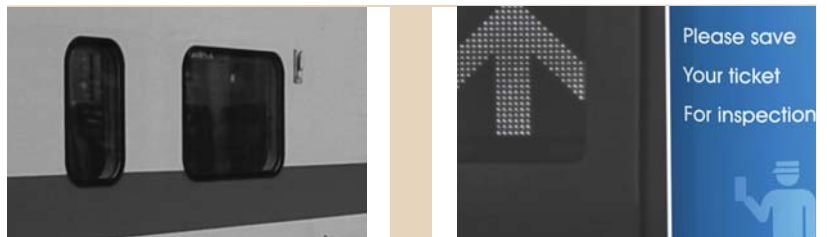



WMV1000/270





■ Compatible sign methods:
Cut vinyl, digitally printed vinyl, engraving,
screen-printing, Braille.

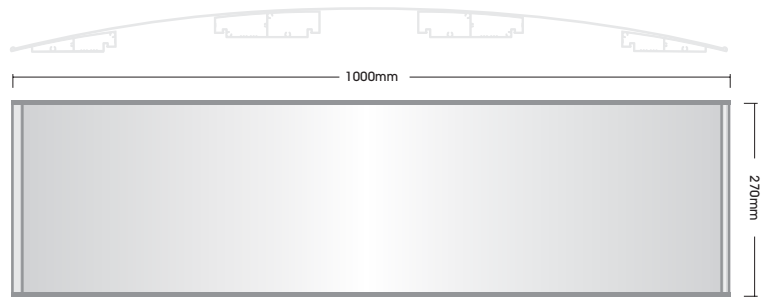

Wall Frames

WMV1000/270
Frame size: 1016/270mm
Insert size: 1014/270mm

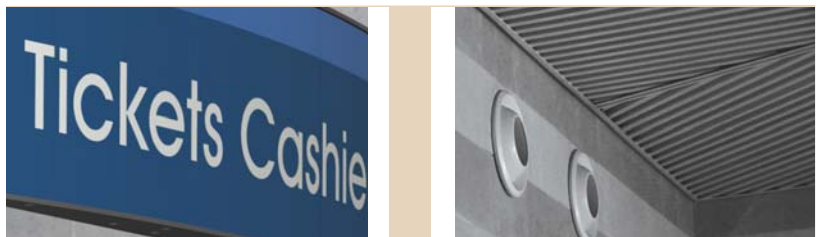



The only way to be sure of catching a train is to miss the one before it. G. K. Chesterton 1874-1936

WMV600/700

Lobby

Ticket type	Weekly	Monthly	Quarterly	Annual
Rail Zones 1 to 3	\$15.50	\$57.50	\$157.50	\$557.50
Rail Zones 1 to 4	\$17.50	\$64.50	\$164.50	\$564.50
Rail Zones 1 to 5	\$23.50	\$77.50	\$177.50	\$577.50
Rail Zones 1 to 6	\$17.50	\$87.50	\$187.50	\$587.50
Rail Zones 2 to 5	\$13.50	\$64.50	\$164.50	\$564.50
School Plus MetroCard	\$6.50	\$89.50	\$189.50	\$589.50
MetroMaster	-	-	-	-

*Available at Metro Travel Centres and Metrotrain Stations and Post Offices.
*Available at certain outlets only.

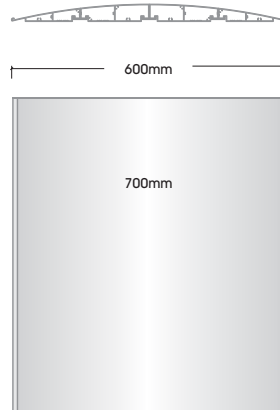

Price List from 27 August 2006

Ticket type	Weekly	Monthly	Quarterly	Annual
Rail Zones 1 to 3	\$15.50	\$57.50	\$157.50	\$557.50
Rail Zones 1 to 4	\$17.50	\$64.50	\$164.50	\$564.50
Rail Zones 1 to 5	\$23.50	\$77.50	\$177.50	\$577.50
Rail Zones 1 to 6	\$17.50	\$87.50	\$187.50	\$587.50
Rail Zones 2 to 5	\$13.50	\$64.50	\$164.50	\$564.50
School Plus MetroCard	\$6.50	\$89.50	\$189.50	\$589.50
MetroMaster	-	-	-	-

*Available at Metro Travel Centres and Metrotrain Stations and Post Offices.
*Available at certain outlets only.

Wall Frames

WMV600/700

Frame size: 600/700mm

Insert size: 597.5/700mm



■ Simple to change the insert

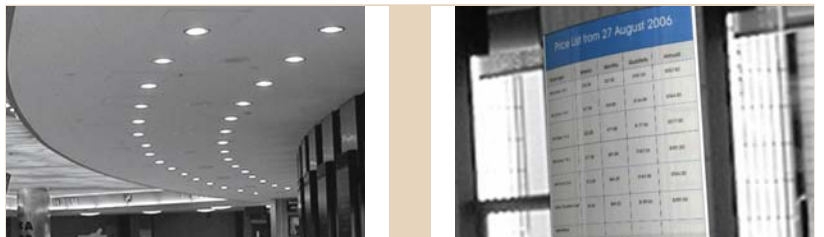



W

hen a train goes through a tunnel and it gets dark, you don't throw away the ticket and jump off. You sit still and trust the engineer. - Corrie Ten Boom, 1892 - 1987

DSV600/600

Lobby



■ A double post and base is shown supporting a double-sided design. Sign frames and post heights are adjustable.



600mm

100mm

600mm

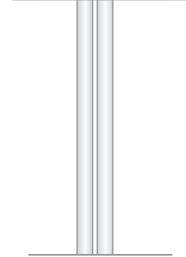

Price List from 27 August 2006

Ticket type	Weekly	Monthly	Quarterly	Annual
Rail Zones 1 to 3	\$15.50	\$57.50	\$157.50	\$557.50
Rail Zones 1 to 4	\$17.50	\$64.50	\$164.50	\$564.50
Rail Zones 1 to 5	\$23.50	\$77.50	\$177.50	\$577.50
Rail Zones 1 to 6	\$17.50	\$67.50	\$187.50	\$587.50
Rail Zones 2 to 5	\$13.50	\$64.50	\$164.50	\$564.50
School Plus MetroCard	\$6.50	\$29.50	\$129.50	\$529.50
MetroMaster	-	-	-	-

Available at Metro Ticket Centres and MetroBike Stations and Post Offices.
Available at certain locations only.

Post Pylons

DSV600/600

Frame size: 600/600mm

Insert size: 597.5/600mm

P40

P60

P80

P100

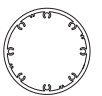



VA4



■ Vista Posts are available in 4 diameters. The system can be ordered in various heights to accommodate a wide range of applications.

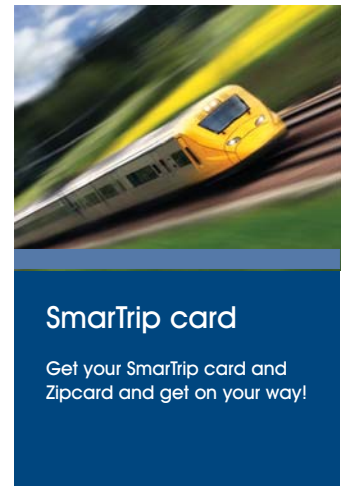
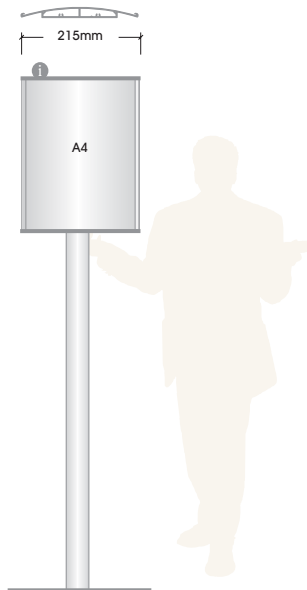

Post Pylons

VA4
 Frame size: 215/297mm
 Insert size: 210/297mm





V200/100

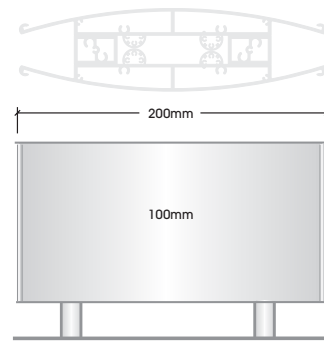
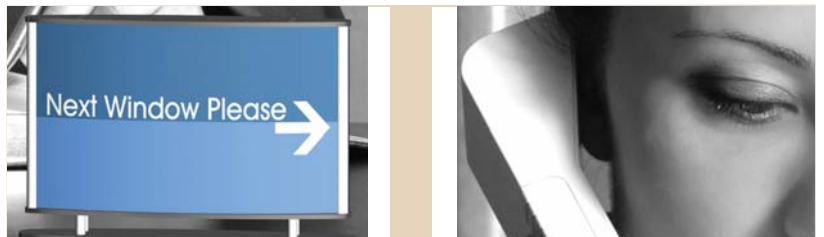

Table Stands

V200/100
 Frame size: 200/100mm
 Insert size: 196/100mm

■ The Table Stand sign frame is offered as a complete package: convex frame, aluminium base and end cap, clear/non glare lens.





VA4/297



■ The Kangaroo style sign frame offered in 9 different widths: 60mm, 80mm, 100mm, 120mm, 150mm, 200mm, A4, Letter, 300mm



Table Stands

VA4/297

Frame size: 215/297mm

Insert size: 210/297mm





DSVL1200/2300



■ This system is used to create freestanding, convex, double sided signs that can be backlit with the addition of interior illumination, or used with standard sign substrates without illumination.

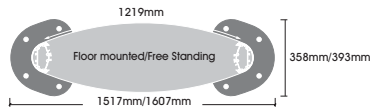

Vista Light

DSVL1200/2300
 Frame size: 1318/2300mm
 Insert size: 1219/2300 mm

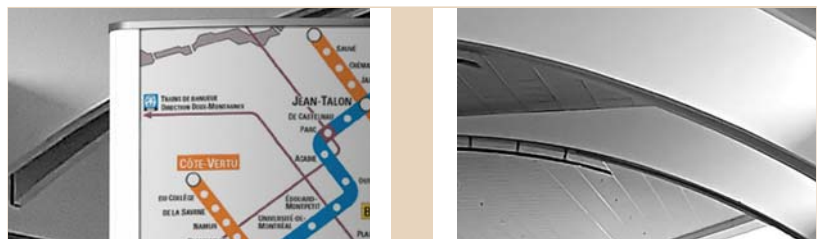



WBV400/400

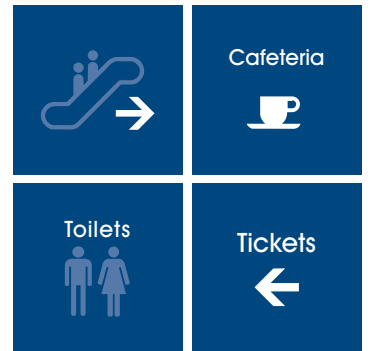
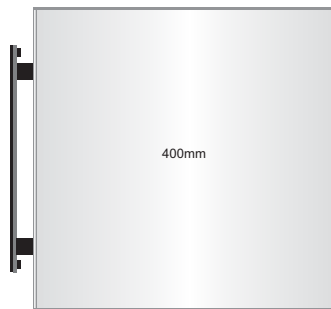
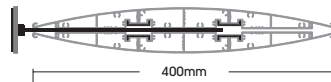

Wall Brackets

WBV400/400
 Frame size: 400/400mm
 Insert size: 369.5/400mm

■ The wall brackets are designed to accept standard size extrusions.

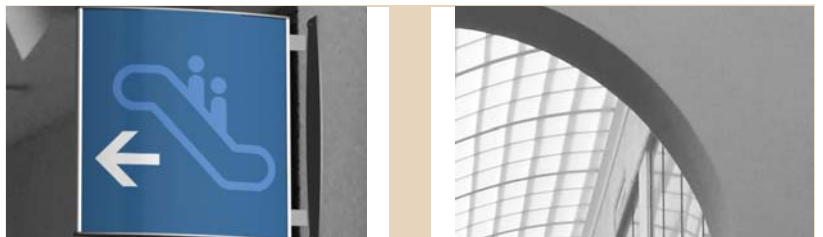



No man can be ideally successful until he has found his place. Like a locomotive he is strong on the track, but weak anywhere else.
Orison Swett Marden

V600/600

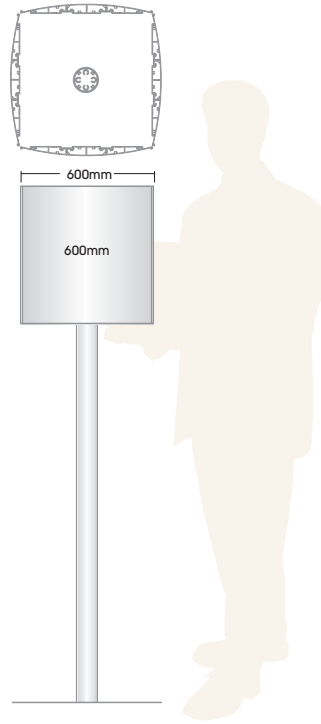

Post Pylons

V600/600
Frame size: 600/600mm
Insert size: 597.5/600mm

■ Four sided post sign. All Vista sign holders accept any sign material that is flat and flexible!





WBV150/300



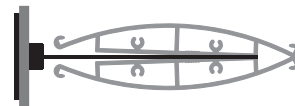

150mm



Wall Brackets

WBV150/300

Frame size: 150/300mm

Insert size: 147/300mm

■ This innovation from Vista System allows for easy installation and removal of the sign for painting or other maintenance.





WBVA4/350

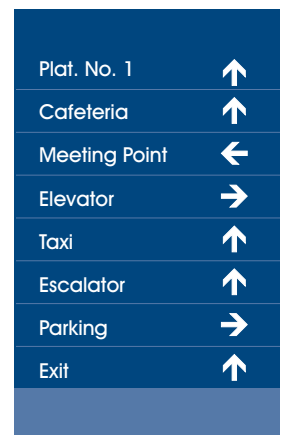
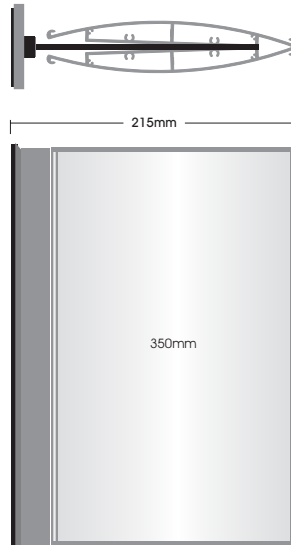

Wall Brackets

WBVA4/350
 Frame size: 215/350mm
 Insert size: 210/350mm

■ Signs that protrude more than 10cm into the path of travel, should be mounted at least 2m from the floor.

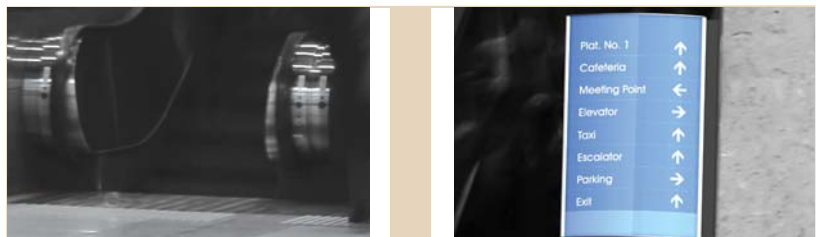

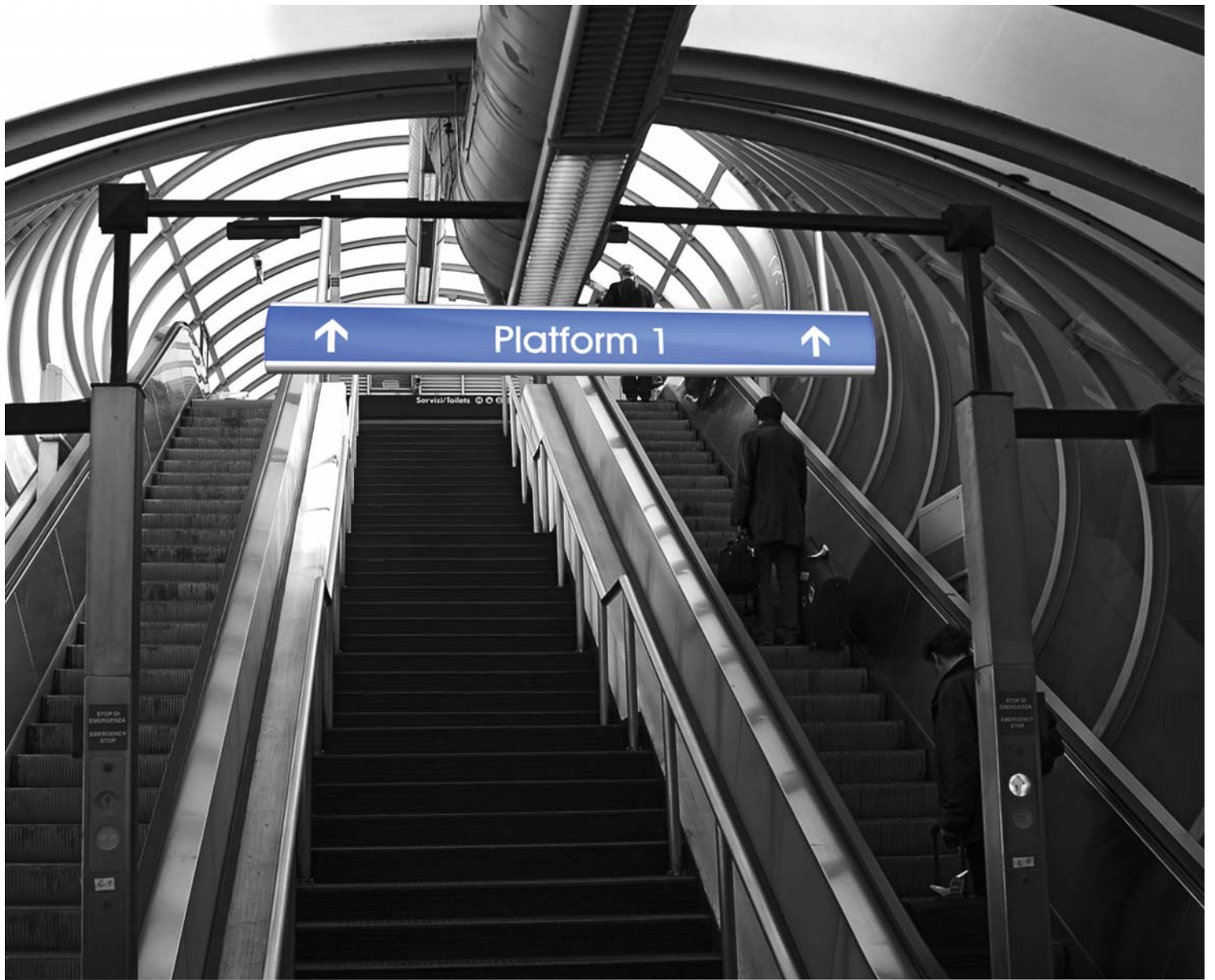

SUSVL250/2500

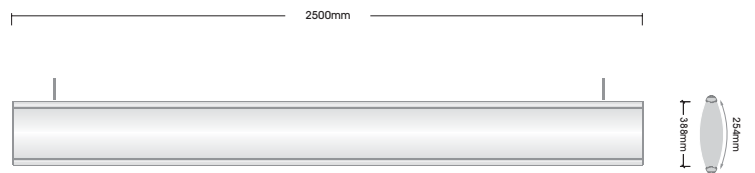
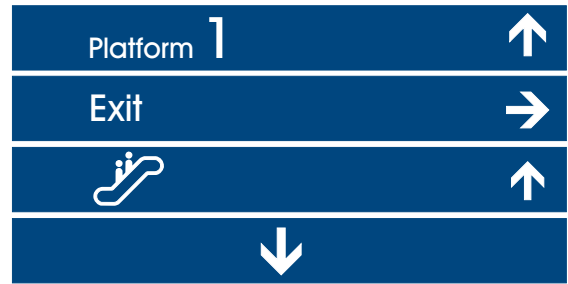

Suspended signs

SUSVL250/2500
 Frame size: 312/2500mm
 Insert size: 254/2500mm

■ The Vista Light series also provides a great solution for suspended signs with internal illumination. The system is lightweight and available in a variety of sizes. Simply insert any flexible material between the extrusions.

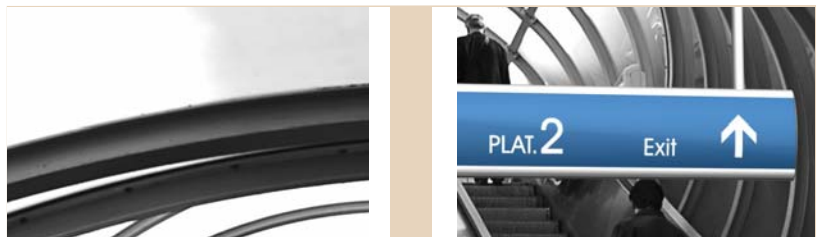



Easy to read, clear signs, that can be positioned to give maximum Information. They blend into the architectural design, while giving information that is simple to understand.

Platforms

Years from now; you may not be able to remember the precise moment you chose Vista System for your project. There is one thing you will remember: Our promise of reliability, because Vista System is designed to fulfill that promise. Vista system components are built to last and to stay worry free.



If you board the wrong train, it's no use running along the corridor in the other direction. - Dietrich Bonhoeffer



Trip Planner on
your phone

WM1200/1443

Platforms

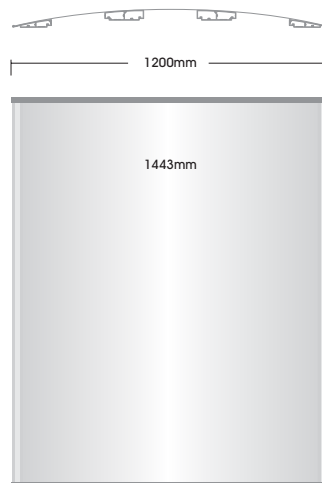
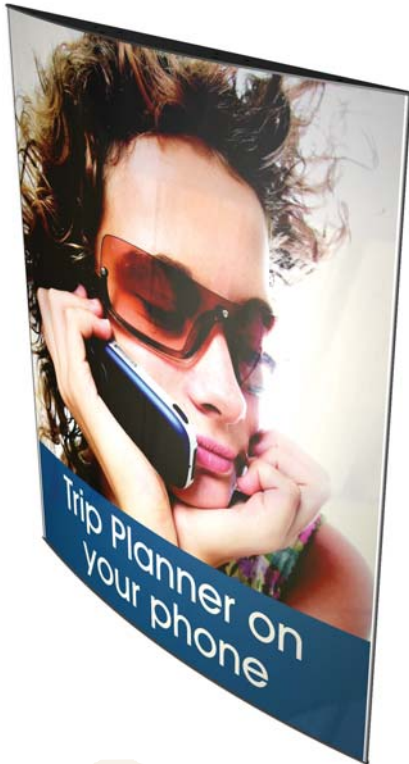

Trip Planner on
your phone

Wall Frames

WM1200/1443

Frame size: 1200/1443mm

Insert size: 1117/1443mm

■ Substrates: Paper + lens, engraving plastics, thin metals, laminates.





*L*ife is a train of moods like a string of beads; and as we pass through them they prove to be many colored lenses, which paint the world their own hue, and each shows us only what lies in its own focus. - Ralph Waldo Emerson

WMV200/750



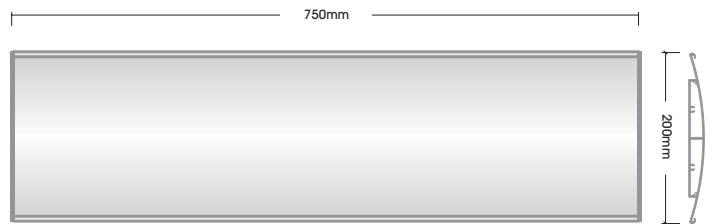

Wall Frames

WMV200/750
Frame size: 200/750mm
Insert size: 196/750mm

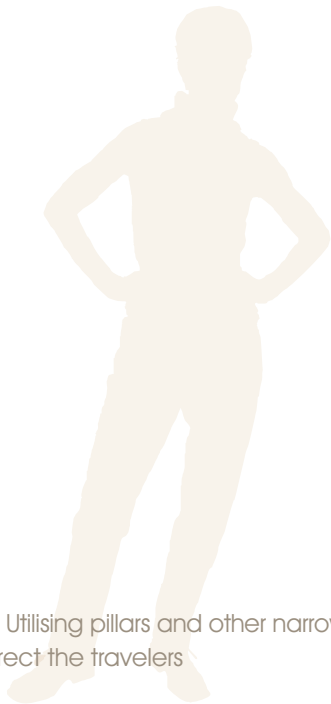

■ Utilising pillars and other narrow surfaces to direct the travelers

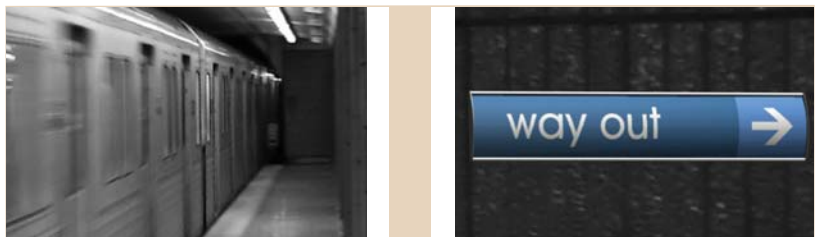

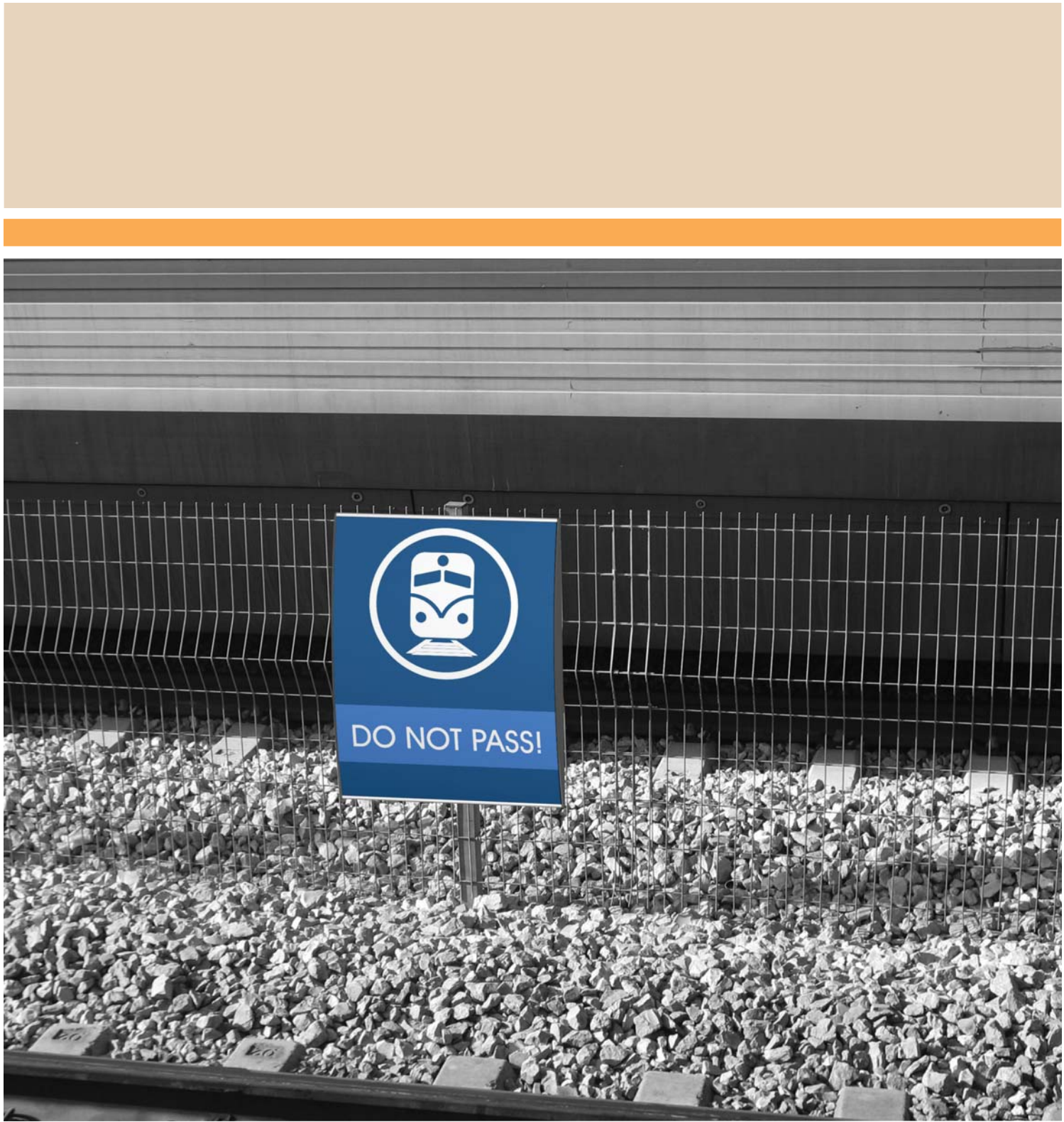

V500/400

Platforms

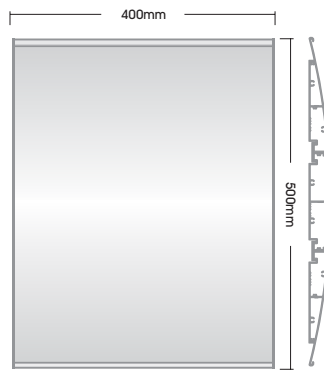

Wall Frames

V500/400

Frame size: 500/400mm

Insert size: 497.5/400mm

■ Vandal resistant.



Never travel without my diary. One should always have something sensational to read in the train. - Oscar Wilde



WMV1200/240



■ Are we there?

Elegant signs, visible to travelers informing them of the station name, directions and other applications.

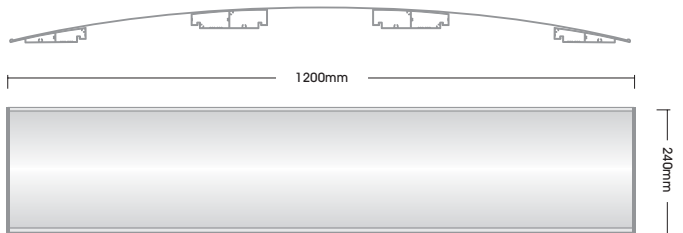

Wall Frames

WMV1200/240

Frame size: 1200/240mm

Insert size: 1218/240mm





There is nothing in machinery, there is nothing in embankments and railways and iron bridges and engineering devices to oblige them to be ugly. Ugliness is the measure of imperfection. - H. G. Wells

WBVL400/400

Platforms

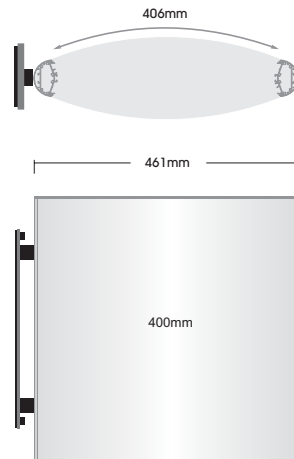

Wall Brackets

WBVL400/400

Frame size: 461/400mm

Insert size: 406/400mm

■ The projecting frames are like small pylon signs. They are attractively priced and provide a clean streamlined appearance and can also be used as an overhead sign mounted to the ceiling.

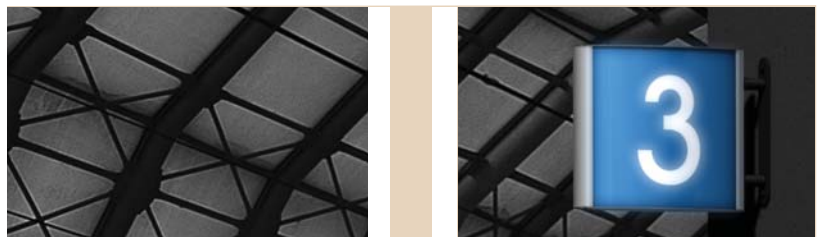



A man who has never gone to school may steal from a freight car, but if he has a university education he may steal the whole railroad. - Franklin Delano Roosevelt

DSV1200/270



■ Suspended double-sided signs with an integrated electronic messaging system.

Expected	Destination	Time
RF2746	Northampton	09:00PM

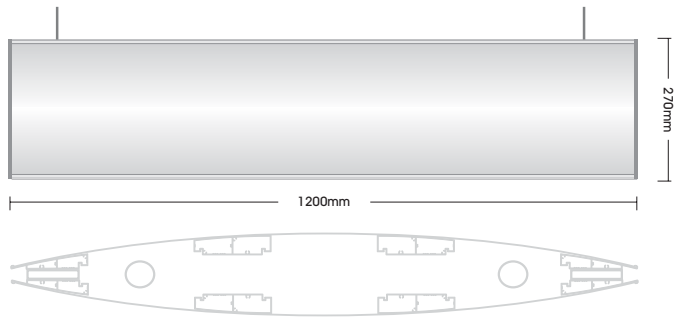

Digital Vista

DSV1200/270
 Frame size: 1200/270mm
 Insert size: 1218/270mm

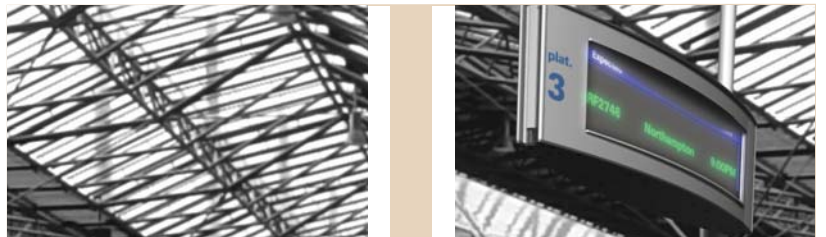

Monday thru Sunday Owl Schedule 2/21/17

Eastbound (Approximate Times)

LOS ANGELES	WEST HOLLYWOOD	HOLLYWOOD	STANFORD BLVD
West Los Angeles Transit Center	Fairfax & Wilshire	Fairfax & Santa Monica	Hollywood & La Brea
		Hollywood & Vine	Hollywood & Western
			Stewart & Vermont
			Monterey & Broadway
9:19P	9:27P	9:37P	9:51P
9:47	9:55	10:04	10:18
10:19	10:27	10:36	10:50
10:55	11:03	11:10	11:24
11:25	11:43	11:50	12:04
11:51	11:59	12:06A	12:20A
1:04A	1:12A	1:19	1:33
2:04	2:12	2:19	2:33
3:04	3:12	3:19	3:33

Monday thru Sunday Owl Schedule 2/21/17

Westbound (Approximate Times)

DOWNTOWN LOS ANGELES	ECHO PARK	HOLLYWOOD	WEST HOLLYWOOD	LOS ANGELES
Bradbury & Venice	Stewart & Echo Park	Hollywood & Vine	Fairfax & Santa Monica	Fairfax & Wilshire
	Vermont & Stewart	Hollywood & La Brea	Fairfax & Santa Monica	Fairfax & Wilshire
				West Los Angeles Transit Center
10:03P	10:20P	10:30P	10:40P	10:50P
10:18	10:35	10:45	10:55	11:05
10:34	10:51	11:01	11:11	11:21
10:51	11:08	11:18	11:28	11:38
11:03	11:20	11:31	11:41	11:51
11:28	11:45	11:56	12:06	12:16
11:54	12:08	12:17	12:27	12:37
12:03A	12:17	12:26	12:36	12:46
12:28	12:42	12:51	13:01	13:11
1:03	1:17	1:26	1:36	1:46
1:28	1:42	1:51	2:01	2:11
2:03	2:17	2:26	2:36	2:46
3:03	3:17	3:26	3:36	3:46
4:03	4:17	4:26	4:36	4:46

Sunday and Holiday Schedule 2/21/17

Eastbound (Approximate Times)

LOS ANGELES	WEST HOLLYWOOD	HOLLYWOOD	STANFORD BLVD
West Los Angeles Transit Center	Fairfax & Wilshire	Fairfax & Santa Monica	Hollywood & La Brea
		Hollywood & Vine	Hollywood & Western
			Stewart & Vermont
			Monterey & Broadway
9:19P	9:27P	9:37P	9:51P
9:47	9:55	10:04	10:18
10:19	10:27	10:36	10:50
10:55	11:03	11:10	11:24
11:25	11:43	11:50	12:04
11:51	11:59	12:06A	12:20A
1:04A	1:12A	1:19	1:33
2:04	2:12	2:19	2:33
3:04	3:12	3:19	3:33

Sunday and Holiday Schedule 2/21/17

Westbound (Approximate Times)

DOWNTOWN LOS ANGELES	ECHO PARK	HOLLYWOOD	WEST HOLLYWOOD	LOS ANGELES
Bradbury & Venice	Stewart & Echo Park	Hollywood & Vine	Fairfax & Santa Monica	Fairfax & Wilshire
	Vermont & Stewart	Hollywood & La Brea	Fairfax & Santa Monica	Fairfax & Wilshire
				West Los Angeles Transit Center
10:03P	10:20P	10:30P	10:40P	10:50P
10:18	10:35	10:45	10:55	11:05
10:34	10:51	11:01	11:11	11:21
10:51	11:08	11:18	11:28	11:38
11:03	11:20	11:31	11:41	11:51
11:28	11:45	11:56	12:06	12:16
11:54	12:08	12:17	12:27	12:37
12:03A	12:17	12:26	12:36	12:46
12:28	12:42	12:51	13:01	13:11
1:03	1:17	1:26	1:36	1:46
1:28	1:42	1:51	2:01	2:11
2:03	2:17	2:26	2:36	2:46
3:03	3:17	3:26	3:36	3:46
4:03	4:17	4:26	4:36	4:46

2W MV1 300/1840

Platforms

Monday thru Sunday Owl Schedule 2/21/17

Eastbound (Approximate Times)

LOS ANGELES	WEST HOLLYWOOD	HOLLYWOOD	STATION
West Los Angeles Transit Center	Fairfax & Wilshire	Fairfax & Santa Monica	Hollywood & La Brea
9:19P	9:29P	9:39P	TRIP ORIGINATES VIA LINE 2
9:47	9:55	10:04	10:10P
10:19	10:27	10:36	10:42P
10:55	11:03	11:10	11:15P
11:25	11:42	11:50	11:55P
11:51	12:08	12:16	12:21P
12:04	12:22	12:30	12:35P
12:16	12:34	12:42	12:47P
12:28	12:46	12:54	12:59P
12:40	13:02	13:10	13:15P
12:52	13:14	13:22	13:27P
13:04	13:26	13:34	13:39P
13:16	13:38	13:46	13:51P
13:28	13:50	13:58	14:03P
13:40	14:02	14:10	14:15P
13:52	14:14	14:22	14:27P
14:04	14:26	14:34	14:39P
14:16	14:38	14:46	14:51P
14:28	14:50	14:58	15:03P
14:40	15:02	15:10	15:15P
14:52	15:14	15:22	15:27P
15:04	15:26	15:34	15:39P
15:16	15:38	15:46	15:51P
15:28	15:50	15:58	16:03P
15:40	16:02	16:10	16:15P
15:52	16:14	16:22	16:27P
16:04	16:26	16:34	16:39P
16:16	16:38	16:46	16:51P
16:28	16:50	16:58	17:03P
16:40	17:02	17:10	17:15P
16:52	17:14	17:22	17:27P
17:04	17:26	17:34	17:39P
17:16	17:38	17:46	17:51P
17:28	17:50	17:58	18:03P
17:40	18:02	18:10	18:15P
17:52	18:14	18:22	18:27P
18:04	18:26	18:34	18:39P
18:16	18:38	18:46	18:51P
18:28	18:50	18:58	19:03P
18:40	19:02	19:10	19:15P
18:52	19:14	19:22	19:27P
19:04	19:26	19:34	19:39P
19:16	19:38	19:46	19:51P
19:28	19:50	19:58	20:03P
19:40	20:02	20:10	20:15P
19:52	20:14	20:22	20:27P
20:04	20:26	20:34	20:39P
20:16	20:38	20:46	20:51P
20:28	20:50	20:58	21:03P
20:40	21:02	21:10	21:15P
20:52	21:14	21:22	21:27P
21:04	21:26	21:34	21:39P
21:16	21:38	21:46	21:51P
21:28	21:50	21:58	22:03P
21:40	22:02	22:10	22:15P
21:52	22:14	22:22	22:27P
22:04	22:26	22:34	22:39P
22:16	22:38	22:46	22:51P
22:28	22:50	22:58	23:03P
22:40	23:02	23:10	23:15P
22:52	23:14	23:22	23:27P
23:04	23:26	23:34	23:39P
23:16	23:38	23:46	23:51P
23:28	23:50	23:58	00:03A
23:40	00:02	00:10	00:15A
23:52	00:14	00:22	00:27A
00:04	00:26	00:34	00:39A
00:16	00:38	00:46	00:51A
00:28	00:50	00:58	01:03A
00:40	01:02	01:10	01:15A
00:52	01:14	01:22	01:27A
01:04	01:26	01:34	01:39A
01:16	01:38	01:46	01:51A
01:28	01:50	01:58	02:03A
01:40	02:02	02:10	02:15A
01:52	02:14	02:22	02:27A
02:04	02:26	02:34	02:39A
02:16	02:38	02:46	02:51A
02:28	02:50	02:58	03:03A
02:40	03:02	03:10	03:15A
02:52	03:14	03:22	03:27A
03:04	03:26	03:34	03:39A
03:16	03:38	03:46	03:51A
03:28	03:50	03:58	04:03A
03:40	04:02	04:10	04:15A
03:52	04:14	04:22	04:27A
04:04	04:26	04:34	04:39A
04:16	04:38	04:46	04:51A
04:28	04:50	04:58	05:03A
04:40	05:02	05:10	05:15A
04:52	05:14	05:22	05:27A
05:04	05:26	05:34	05:39A
05:16	05:38	05:46	05:51A
05:28	05:50	05:58	06:03A
05:40	06:02	06:10	06:15A
05:52	06:14	06:22	06:27A
06:04	06:26	06:34	06:39A
06:16	06:38	06:46	06:51A
06:28	06:50	06:58	07:03A
06:40	07:02	07:10	07:15A
06:52	07:14	07:22	07:27A
07:04	07:26	07:34	07:39A
07:16	07:38	07:46	07:51A
07:28	07:50	07:58	08:03A
07:40	08:02	08:10	08:15A
07:52	08:14	08:22	08:27A
08:04	08:26	08:34	08:39A
08:16	08:38	08:46	08:51A
08:28	08:50	08:58	09:03A
08:40	09:02	09:10	09:15A
08:52	09:14	09:22	09:27A
09:04	09:26	09:34	09:39A
09:16	09:38	09:46	09:51A
09:28	09:50	09:58	10:03A
09:40	10:02	10:10	10:15A
09:52	10:14	10:22	10:27A
10:04	10:26	10:34	10:39A
10:16	10:38	10:46	10:51A
10:28	10:50	10:58	11:03A
10:40	11:02	11:10	11:15A
10:52	11:14	11:22	11:27A
11:04	11:26	11:34	11:39A
11:16	11:38	11:46	11:51A
11:28	11:50	11:58	12:03A
11:40	12:02	12:10	12:15A
11:52	12:14	12:22	12:27A
12:04	12:26	12:34	12:39A
12:16	12:38	12:46	12:51A
12:28	12:50	12:58	01:03A
12:40	01:02	01:10	01:15A
12:52	01:14	01:22	01:27A
01:04	01:26	01:34	01:39A
01:16	01:38	01:46	01:51A
01:28	01:50	01:58	02:03A
01:40	02:02	02:10	02:15A
01:52	02:14	02:22	02:27A
02:04	02:26	02:34	02:39A
02:16	02:38	02:46	02:51A
02:28	02:50	02:58	03:03A
02:40	03:02	03:10	03:15A
02:52	03:14	03:22	03:27A
03:04	03:26	03:34	03:39A
03:16	03:38	03:46	03:51A
03:28	03:50	03:58	04:03A
03:40	04:02	04:10	04:15A
03:52	04:14	04:22	04:27A
04:04	04:26	04:34	04:39A
04:16	04:38	04:46	04:51A
04:28	04:50	04:58	05:03A
04:40	05:02	05:10	05:15A
04:52	05:14	05:22	05:27A
05:04	05:26	05:34	05:39A
05:16	05:38	05:46	05:51A
05:28	05:50	05:58	06:03A
05:40	06:02	06:10	06:15A
05:52	06:14	06:22	06:27A
06:04	06:26	06:34	06:39A
06:16	06:38	06:46	06:51A
06:28	06:50	06:58	07:03A
06:40	07:02	07:10	07:15A
06:52	07:14	07:22	07:27A
07:04	07:26	07:34	07:39A
07:16	07:38	07:46	07:51A
07:28	07:50	07:58	08:03A
07:40	08:02	08:10	08:15A
07:52	08:14	08:22	08:27A
08:04	08:26	08:34	08:39A
08:16	08:38	08:46	08:51A
08:28	08:50	08:58	09:03A
08:40	09:02	09:10	09:15A
08:52	09:14	09:22	09:27A
09:04	09:26	09:34	09:39A
09:16	09:38	09:46	09:51A
09:28	09:50	09:58	10:03A
09:40	10:02	10:10	10:15A
09:52	10:14	10:22	10:27A
10:04	10:26	10:34	10:39A
10:16	10:38	10:46	10:51A
10:28	10:50	10:58	11:03A
10:40	11:02	11:10	11:15A
10:52	11:14	11:22	11:27A
11:04	11:26	11:34	11:39A
11:16	11:38	11:46	11:51A
11:28	11:50	11:58	12:03A
11:40	12:02	12:10	12:15A
11:52	12:14	12:22	12:27A
12:04	12:26	12:34	12:39A
12:16	12:38	12:46	12:51A
12:28	12:50	12:58	01:03A
12:40	01:02	01:10	01:15A
12:52	01:14	01:22	01:27A
01:04	01:26	01:34	01:39A
01:16	01:38	01:46	01:51A
01:28	01:50	01:58	02:03A
01:40	02:02	02:10	02:15A
01:52	02:14	02:22	02:27A
02:04	02:26	02:34	02:39A
02:16	02:38	02:46	02:51A
02:28	02:50	02:58	03:03A
02:40	03:02	03:10	03:15A
02:52	03:14	03:22	03:27A
03:04	03:26	03:34	03:39A
03:16	03:38	03:46	03:51A
03:28	03:50	03:58	04:03A
03:40	04:02	04:10	04:15A
03:52	04:14	04:22	04:27A
04:04	04:26	04:34	04:39A
04:16	04:38	04:46	04:51A
04:28	04:50	04:58	05:03A
04:40	05:02	05:10	05:15A
04:52	05:14	05:22	05:27A
05:04	05:26	05:34	05:39A
05:16	05:38	05:46	05:51A
05:28	05:50	05:58	06:03A
05:40	06:02	06:10	06:15A
05:52	06:14	06:22	06:27A
06:04	06:26	06:34	06:39A
06:16	06:38	06:46	06:51A
06:28	06:50	06:58	07:03A
06:40	07:02	07:10	07:15A
06:52	07:14	07:22	07:27A
07:04	07:26	07:34	07:39A
07:16	07:38	07:46	07:51A
07:28	07:50	07:58	08:03A
07:40	08:02	08:10	08:15A
07:52	08:14	08:22	08:27A
08:04	08:26	08:34	08:39A
08:16	08:38	08:46	08:51A
08:28	08:50	08:58	09:03A
08:40	09:02	09:10	09:15A
08:52	09:14	09:22	09:27A
09:04	09:26	09:34	09:39A
09:16	09:38		

All Vista System signs accept Braille and tactile inserts. No need for a separate system for the disabled.

Parking

Vista System's has the ability to accept an unlimited array of sign substrate materials that run the gamut of finishes and colours to compliment what the architect had in mind. These materials include any flat and flexible sheet materials.





VA4+P40

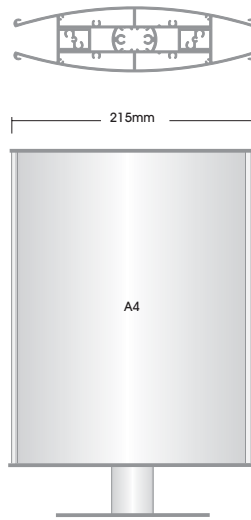

Special Mount

VA4+P40
Frame size: 215/297mm
Insert size: 210/297mm

■ Designed to accept standard paper or other signage substrates.





SUSVA4/220

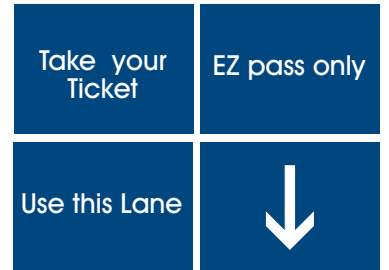
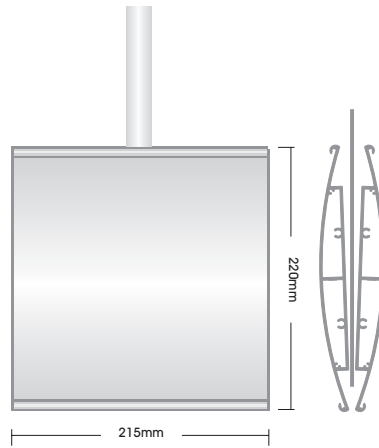

Suspended signs

SUSVA4/220
 Frame size: 215/220mm
 Insert size: 210/220mm

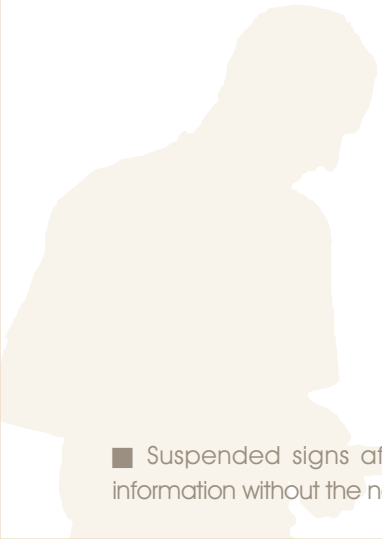

■ Suspended signs afford the passenger information without the need to stop and look.





Long term parking

I

*t's all right for you to have a train of thought if you also have a terminal.
- Anonymous*

SUSVA4/1000

Parking



■ Clear highly visible illuminated car-park signs.

Entrance



Fasten Seat Belts

Exit



Long term parking

Reserved parking

Caution!

Car coming



Pick up only

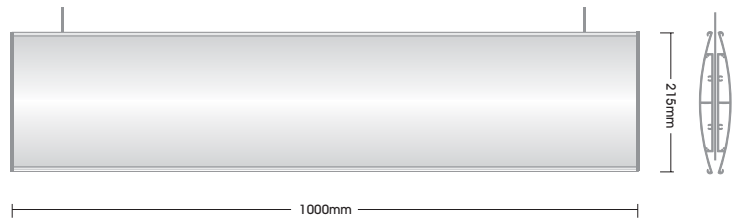

Suspended signs

SUSVA4/1000

Frame size: 215/1000mm

Insert size: 210/1000mm





V600/1800



■ A pylon located near the entrance designed to display illuminated announcements.



600mm



1800mm

Welcome to central station parking lot

Level 1 **Full**

Level 2 **Open**

Parking Fees:
Parking hour 2.25\$
Add 1/2 Hr. 1.25\$
Daily Max 8.75\$

Double Sided Pylons

V600/1800

Frame size: 600/1800mm

Insert size: 597.5/1800mm

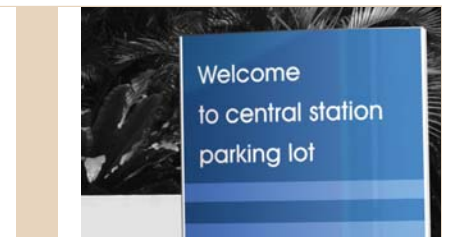



VL250/2000



■ Also great for show rooms, lobbies, displays, parking garages, advertising, point of sale, shopping centres, trade shows etc.

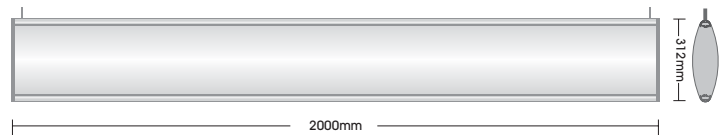
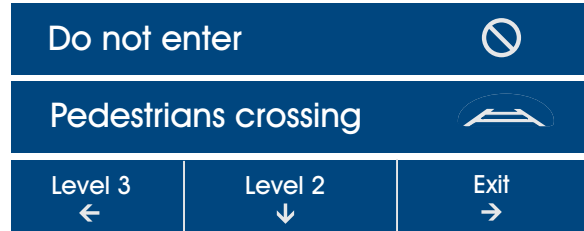

Suspended signs

VL250/2000

Frame size: 312/2000mm

Insert size: 254/2000mm





Neither a wise man nor a brave man lies down on the tracks of history to wait for the train of the future to run over him. - Dwight D. Eisenhower, 1890 - 1969

VL250/1000

Parking



■ The system is lightweight and available in a variety of sizes. Simply insert any flexible material between the extrusions.

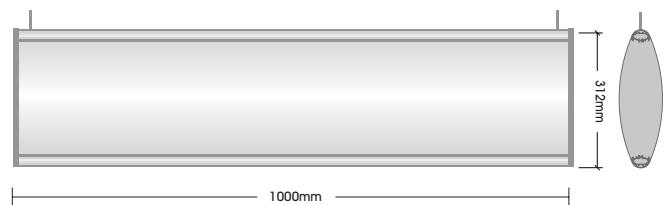
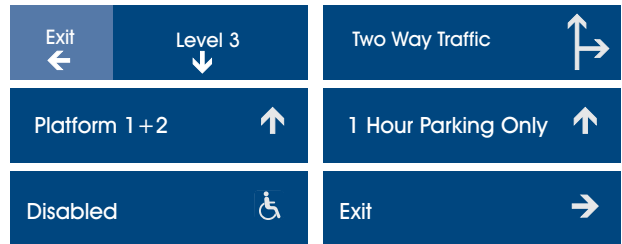

suspended signs

VL250/1000

Frame size: 312/1000mm

Insert size: 254/1000mm





V1000/650+V1000/220

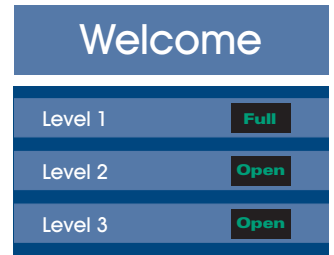
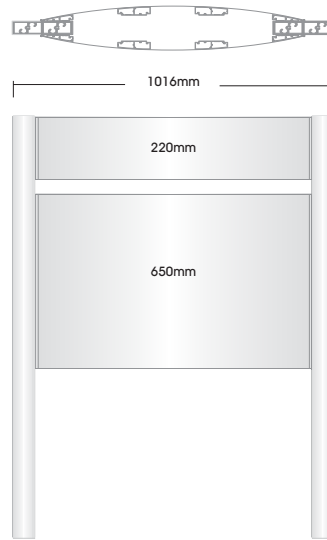

Double Sided Pylons

V1000/650mm+V1000/220

Frame size: 1016/650mm, 1016/220mm

Insert size: 1014/650mm, 1014/220mm

■ Clear highly visible LED car-park signs.

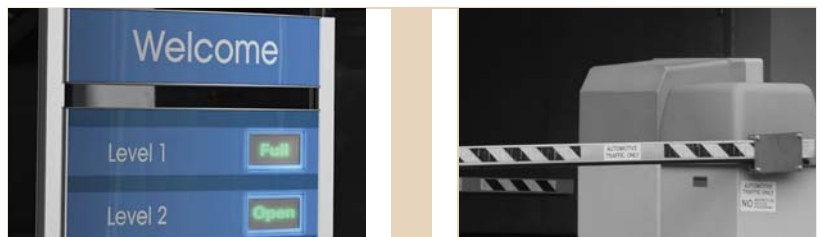



VA4/600/P40/1200

Parking



■ Post mounted, information/location sign.

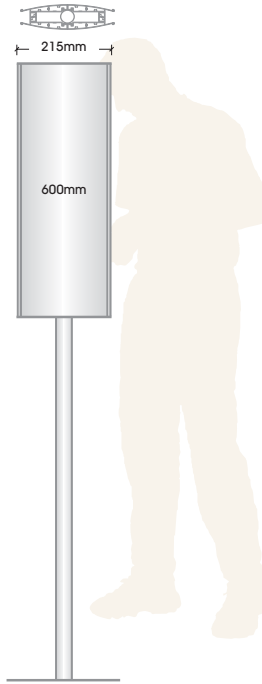

Double Sided Pylons

VA4/600/P40/1200

Frame size: 215/600mm

Insert size: 210/600mm





WBV400/400

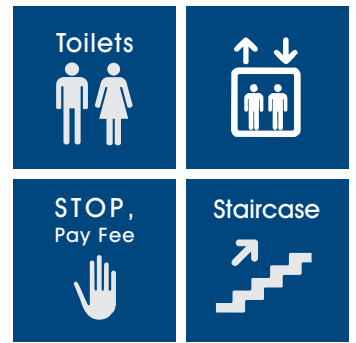
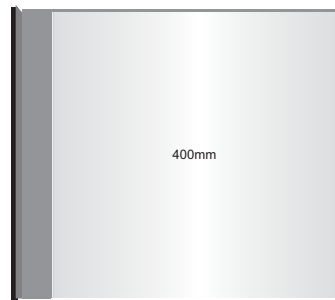
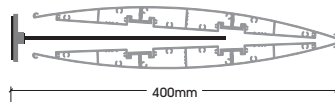

Wall Brackets

WBV400/400

Frame size: 400/400mm

Insert size: 396.5/400mm





R

*ailway termini ... are our gates to the glorious and the unknown. Through them we pass out into
adventure and sunshine, to them, alas, we return. - Edward Morgan Forster, 1879 - 1970*

VL250/350/P60/1800

Parking



■ A single post and base is shown supporting a double-sided Vista Light design. Sign frames and post heights are adjustable.

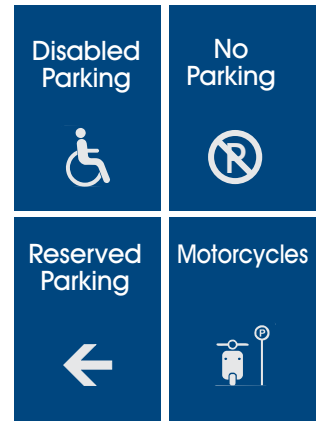
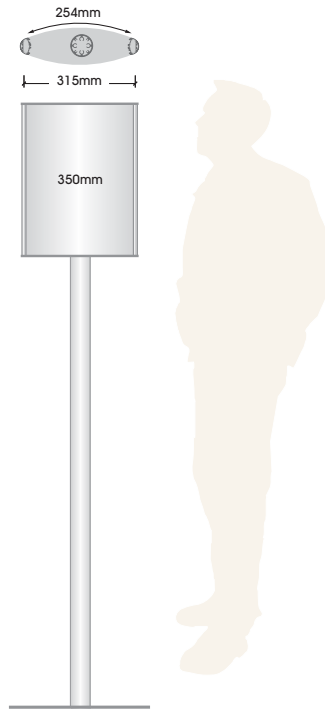

Post Pylons

VL250/350/P60/1800
 Frame size: 315/350mm
 Insert size: 254/350mm



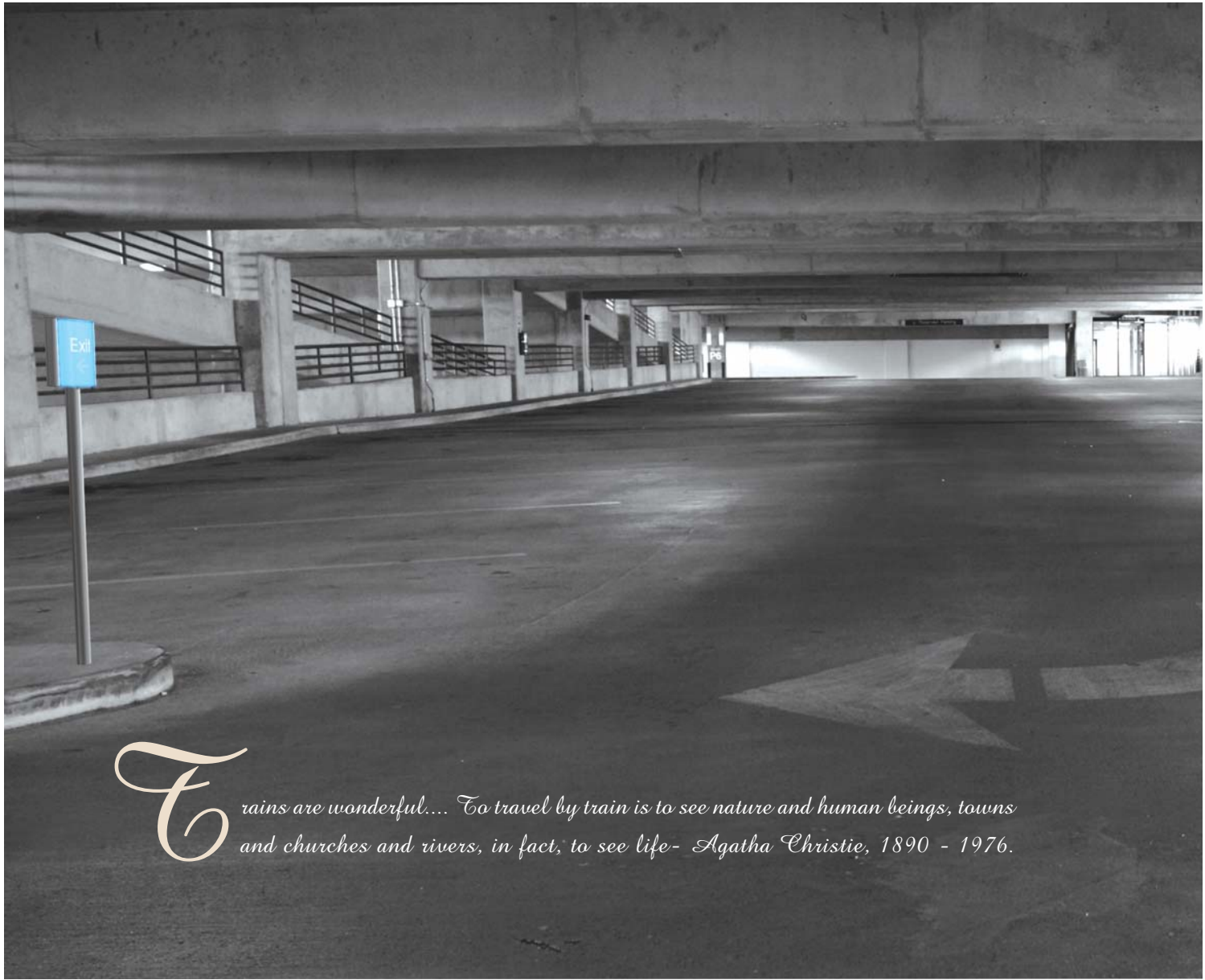

*T*rains are wonderful... To travel by train is to see nature and human beings, towns and churches and rivers, in fact, to see life- Agatha Christie, 1890 - 1976.

VL400/400/P80/1800

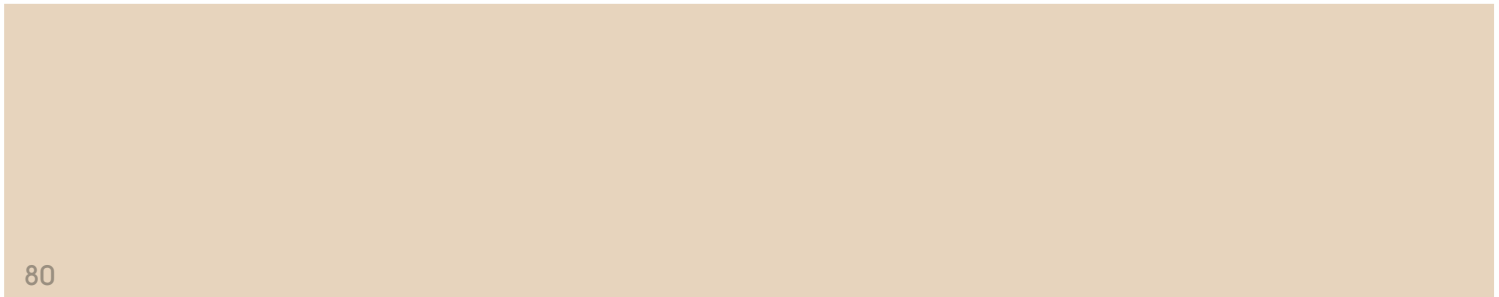

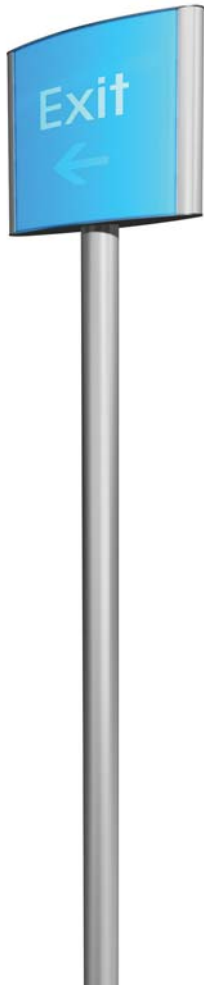

■ Tall visible post signs for direction & identification in open areas.

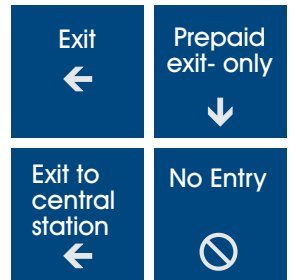
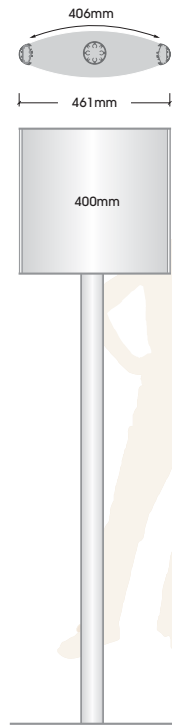

Post Pylons

VL400/400/P80/1800
 Frame size: 461/400mm
 Insert size: 406/400mm



*D*irectional signs and information is paramount in today's bustling world of rail transportation.

Interior Signs

Vista offers a new concept for the sign industry that was developed by sign professionals with the goal of filling a gap between fabricated sign and modular sign systems. MCFT (Modular Curved Frame Technology) offers the best of both worlds by providing the advantages of a modern modular system with the ability to provide a bespoke solution that meets the unique requirements of each sign project. Vista stocks the entire collection of system components for fast delivery from strategically located centers around the world.





V120/120

Interior Signs

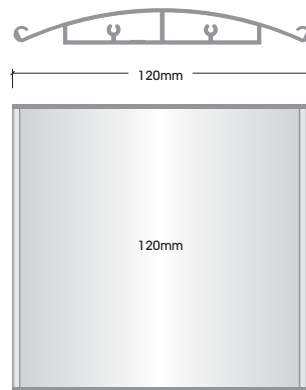

Wall Frames

V120/120

Frame size: 120/120mm

Insert size: 117/120mm

■ Compatible signage methods:
Cut vinyl, digitally printed vinyl, engraving,
screen-printing, Braille and Tactile.

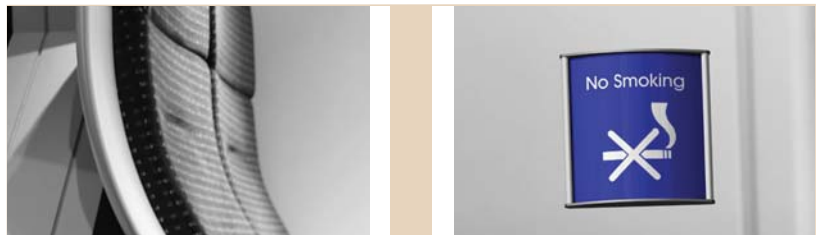



DSV200/260

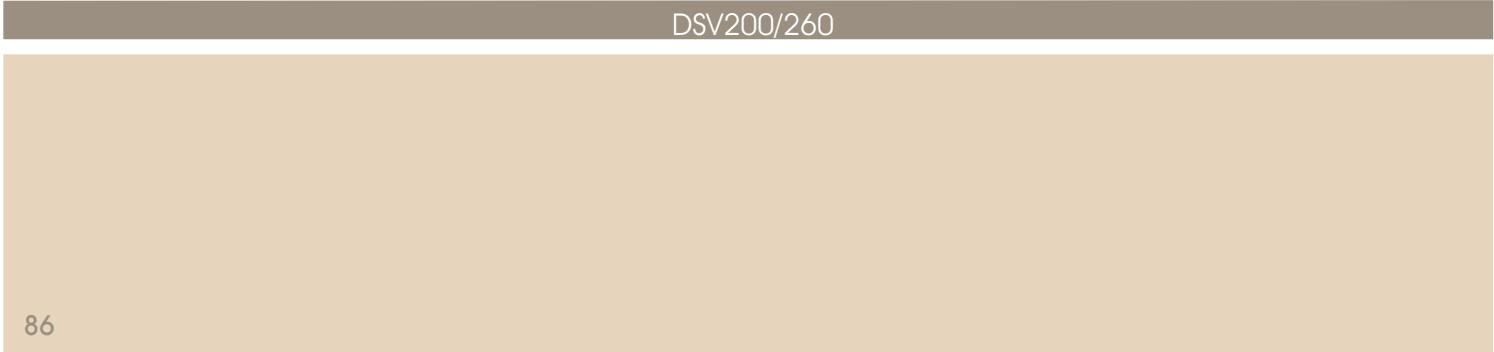

Interior Signs



200mm



260mm

Plan your journey

A new journey is always exciting – these tips will help you prepare and make it stress free! Before starting your new school, you can:
 Look at a map and find your house and your school.
 Decide how to get from your house to your school.
 Find the safest route to walk or cycle.
 Find out how to get there by bus.
 Get it timetable.
 Find out the bus times.
 Decide where to catch the bus.
 Find out about passes and fares.
 Have a backup plan in case you miss the bus – ask your parents.
 Practise the route!



Double Sided Pylons

DSV200/260

Frame size: 200/260mm

Insert size: 196/260mm

■ The system will accept a variety of standard inserts, substrates, including: paper, plastic, metal, laminates, sublimations, metal photo, etc...





WMV80/250

Interior Signs

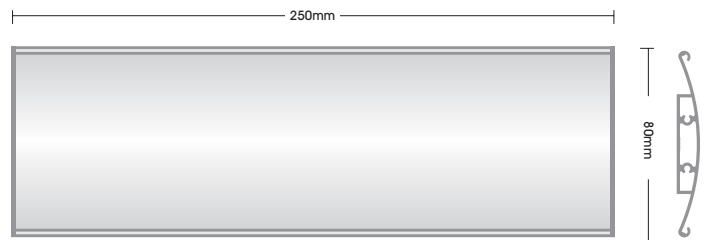

Wall Frames

WMV80/250

Frame size: 80/250mm

Insert size: 77.5/250mm

■ OK, this is our car. Do you want the window seat?

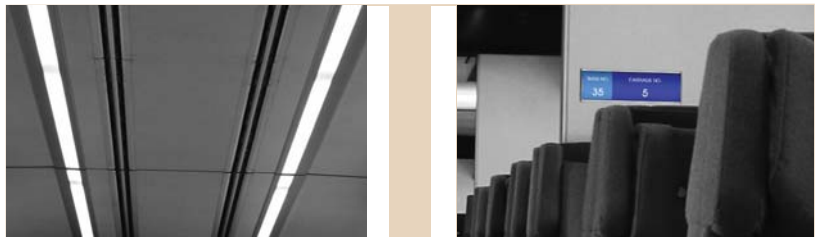



VA4/1000

Interior Signs



■ Where are we? What can we buy when we get there?

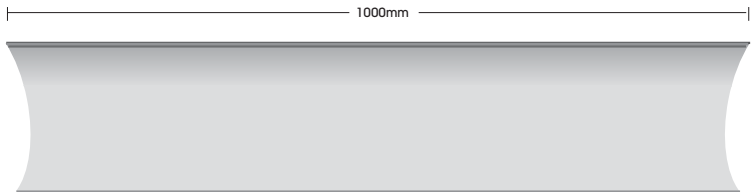

Wall Frames

VA4/1000

Frame size: 215/1000mm

Insert size: 210/1000mm





V500/600

Interior Signs

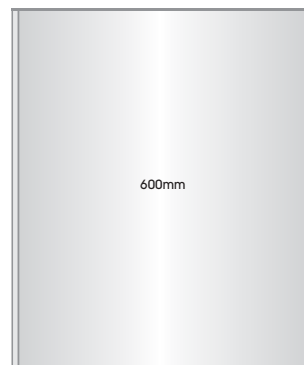
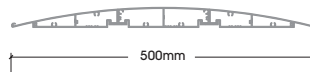

Wall Frames

V500/600

Frame size: 500/600mm

Insert size: 497.5/600mm

■ General wall frame, used with a Map.



Tough signs for busy environments

Way finding products located within the reach of a crowd need to be tough. Vandalism frequently leads to damage to the signs. Cleaning staff, often need to use strong detergents and coarse cleaning materials which can also damage the signs.

Vista System utilises state-of-the-art technology to produce sign solutions made from hard anodised Aluminium and powder-coated steel. With MCFT, end caps remain firmly in place thanks to ultra strong screws. All parts are attached together using extremely strong materials without compromising the neat and modern design. Vista system is a frame system; any flat and flexible substrate can be flexed and inserted in to the frame and reinforced to keep it in place! Through simply choosing a tough sign insert, maximum protection is achieved. In rare cases where vandalism to a sign occurs the cost of replacing the insert instead of the whole sign is minimal. The replacement job is fast and easy, even by a novice.

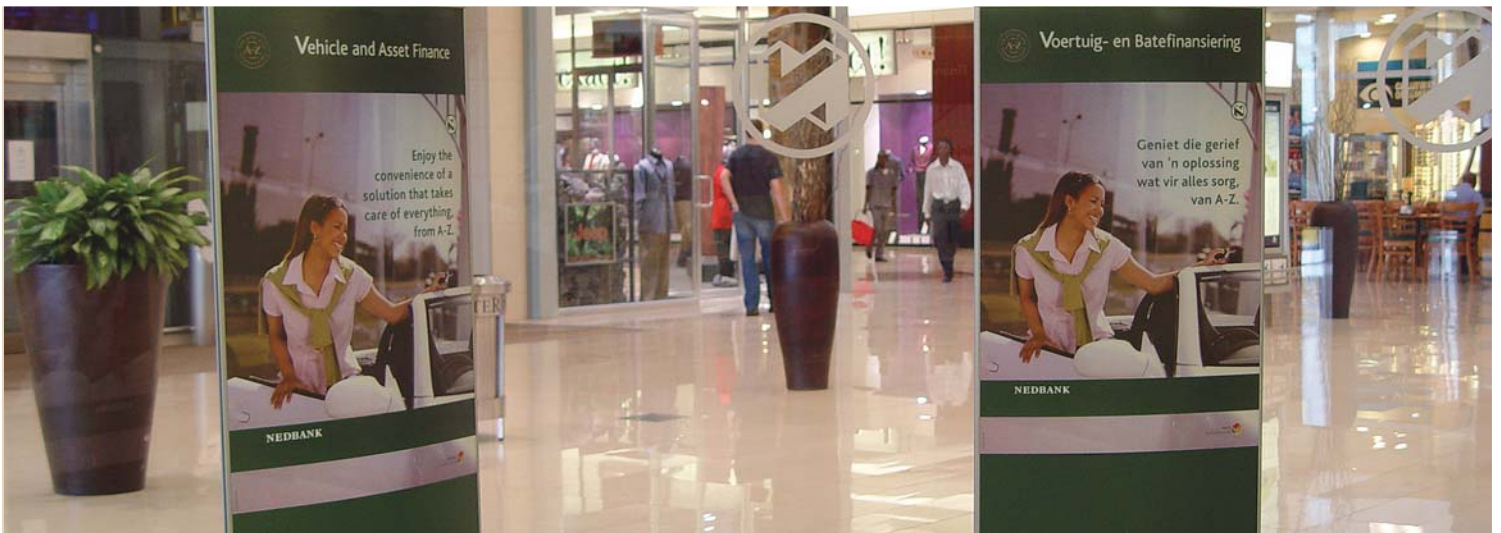

We do it your **Way-Finding**



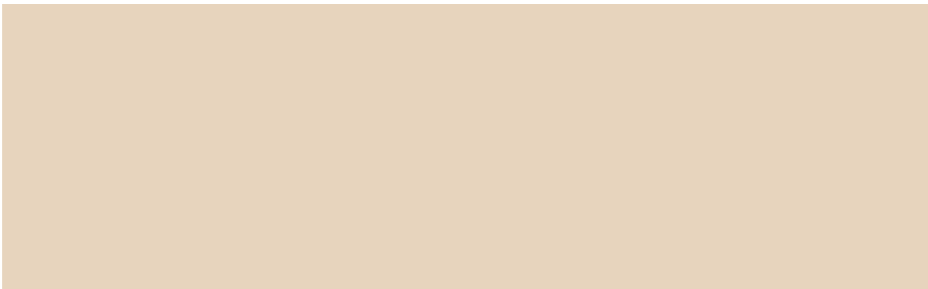

www.vistasystem.com